

Data sheet | Item number: 765-1203/100-000

16-channel digital output; EtherCAT; DC 24 V / 2.0 A; 8xM12 connection;
WideLine

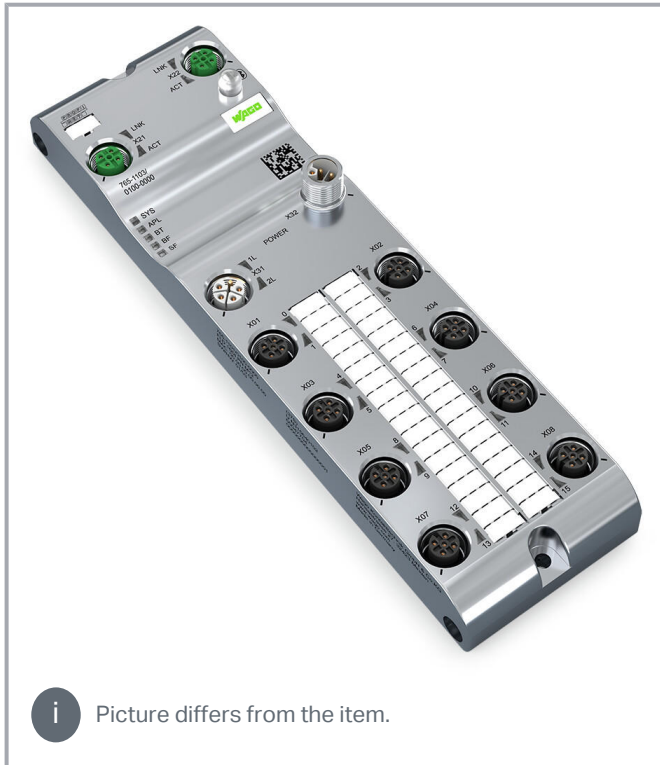

www.wago.com/765-1203/100-000



i Picture differs from the item.

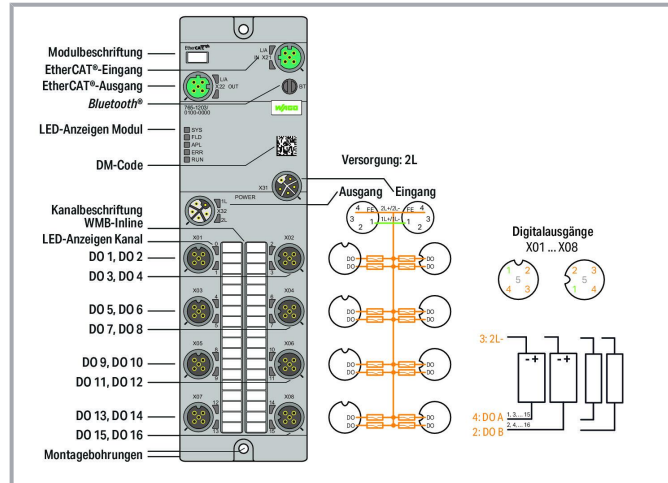

Data

Technical data

Fieldbus

Communication	EtherCAT AoE, EoE, FoE
Connection technology: communication/fieldbus	2 x D-coded M12; 4-pole
Interface standard	10BASE-T/100BASE-TX; potential-free
Autonegotiation; autocrossover	yes

Device Functions

Parameters	Output current Temperature
------------	-------------------------------

Subject to changes. Please also observe the further product documentation!

WAGO GmbH & Co. KG
Hansastr. 27
32423 Minden
Phone: +49571 887-0 | Fax: +49571 887-169
Email: info.de@wago.com | Web: www.wago.com

Do you have any questions about our products?
We are always happy to take your call at +49 (571) 887-44222.



Diagnostics	Undervoltage; Overcurrent; Overload; Overtemperature
Device functions	Bluetooth® Bluetooth® OPC UA Server
Visualization	Android/iOS app Webserver

Digital inputs/outputs

Number of digital outputs	16
Connection technology: inputs/outputs	8 x A-coded M12; 5-pole
Voltage signal type	24 VDC
Output current (per channel)	2 A (typ.) for DO
Supply current per port	1L/2L: 4 A (max.)

Module Power Supply

Connection technology: supply	2 x L-coded M12; 5-pole
Supply voltage	24 VDC (18 ... 31.2 V); 1L/2L
Power consumption (max.)	16000 mA
Power consumption (note)	per supply line; overload- and short-circuit-protected
Reverse voltage protection	Yes

Geometrical Data

Width	60 mm / 2.362 inch
Height	30 mm / 1.181 inch
Depth	210 mm / 8.268 inch

Mechanical Data

Weight	610 g
Conformity marking	CE

Environmental Requirements

Surrounding air temperature (operation)	-25 ... +70 °C
Surrounding air temperature (storage)	-40 ... +80 °C
Protection type	IP67
Protection class	III per EN 61140, IEC 61140, VDE 0140-1
Operating altitude	0 ... 2000 m
Pollution degree (5)	3 per EN 60664-1

Subject to changes. Please also observe the further product documentation!

WAGO GmbH & Co. KG
Hansastr. 27
32423 Minden
Phone: +49571 887-0 | Fax: +49571 887-169
Email: info.de@wago.com | Web: www.wago.com

Do you have any questions about our products?
We are always happy to take your call at +49 (571) 887-44222.

Overvoltage category	II (EN 60664-1)
Relative humidity (without condensation)	95 %
Vibration resistance	5g per IEC 60068-2-6
Shock resistance	Short-term: 50g/11 ms/half-sine per IEC 60068-2-27; Long-term: 30g/6 ms/half-sine per IEC 60068-2-29
EMC immunity to interference	per EN 61000-6-2
EMC emission of interference	per EN 61000-6-4

Commercial data



PU (SPU)	1 Pieces
Packaging type	BOX
Country of origin	DE
GTIN	4055144010138
Customs tariff number	85371098990

Required accessories



Tool

Assembly tool		
	Item no.: 206-701 Torque wrench M8 and M12; Assembly kit	www.wago.com/206-701

Cover

Cover		
	Item no.: 756-8102 M12 protective cap; for unused sockets	www.wago.com/756-8102
	Item no.: 756-8103 M12 protective cap; for unused plugs	www.wago.com/756-8103

Marking accessories

Marking strip		
	Item no.: 2009-110 Marking strips; for Smart Printer; on reel; not stretchable; plain; snap-on type; white	www.wago.com/2009-110
Marker		
	Item no.: 2009-115 WMB-Inline; for Smart Printer; 1500 pieces on roll; stretchable 5 - 5.2 mm; plain; snap-on type; white	www.wago.com/2009-115

Optional accessories

Cables and pluggable connectors

Sensor/actuator cable		
-----------------------	--	--

Subject to changes. Please also observe the further product documentation!



Item no.: 756-5402/040-010

Sensor/Actuator cable; M12A socket; straight; M12A plug; angled; 4-pole; Length: 1 m

www.wago.com/756-5402/040-010

Item no.: 756-5402/040-020

Sensor/Actuator cable; M12A socket; straight; M12A plug; angled; 4-pole; Length: 2 m

www.wago.com/756-5402/040-020

Item no.: 756-5311/040-050

Sensor/Actuator cable; M12A plug; straight; 4-pole; Length: 5 m

www.wago.com/756-5311/040-050

Item no.: 756-5311/040-015

Sensor/Actuator cable; M12A plug; straight; 4-pole; Length: 1.5 m

www.wago.com/756-5311/040-015

Item no.: 756-5311/040-100

Sensor/Actuator cable; M12A plug; straight; 4-pole; Length: 10 m

www.wago.com/756-5311/040-100

Item no.: 756-5404/040-020

Sensor/Actuator cable; M12A socket; angled; M12A plug; angled; 4-pole; Length: 2 m

www.wago.com/756-5404/040-020

Item no.: 756-5510/040-010

Sensor/Actuator cable; M8 socket; angled; M12A plug; angled; 4-pole; Length: 1 m

www.wago.com/756-5510/040-010

Item no.: 756-5510/040-020

Sensor/Actuator cable; M8 socket; angled; M12A plug; angled; 4-pole; Length: 2 m

www.wago.com/756-5510/040-020

Item no.: 756-5401/040-020

Sensor/Actuator cable; M12A socket; straight; M12A plug; straight; 4-pole; Length: 2 m

www.wago.com/756-5401/040-020

Item no.: 756-5401/040-010

Sensor/Actuator cable; M12A socket; straight; M12A plug; straight; 4-pole; Length: 1 m

www.wago.com/756-5401/040-010

Item no.: 756-5507/040-010

Sensor/Actuator cable; M8 socket; straight; M12A plug; straight; 4-pole; Length: 1 m

www.wago.com/756-5507/040-010

Item no.: 756-5507/040-020

Sensor/Actuator cable; M8 socket; straight; M12A plug; straight; 4-pole; Length: 2 m

www.wago.com/756-5507/040-020

Item no.: 756-5404/040-010

Sensor/Actuator cable; M12A socket; angled; M12A plug; angled; 4-pole; Length: 1 m

www.wago.com/756-5404/040-010

Subject to changes. Please also observe the further product documentation!

WAGO GmbH & Co. KG

Hansastr. 27

32423 Minden

Phone: +49571 887-0 | Fax: +49571 887-169

Email: info.de@wago.com | Web: www.wago.com

Do you have any questions about our products?

We are always happy to take your call at +49 (571) 887-44222.

Item no.: 756-5312/040-015
Sensor/Actuator cable; M12B socket; straight; 4-pole; Length: 1.5 m

www.wago.com/756-5312/040-015

Item no.: 756-5312/040-050
Sensor/Actuator cable; M12B socket; straight; 4-pole; Length: 5 m

www.wago.com/756-5312/040-050

Item no.: 756-5509/040-010
Sensor/Actuator cable; M8 socket; angled; M12A plug; straight; 4-pole; Length: 1 m

www.wago.com/756-5509/040-010

Item no.: 756-5509/040-020
Sensor/Actuator cable; M8 socket; angled; M12A plug; straight; 4-pole; Length: 2 m

www.wago.com/756-5509/040-020

Item no.: 756-5403/040-010
Sensor/Actuator cable; M12A socket; angled; M12A plug; straight; 4-pole; Length: 1 m

www.wago.com/756-5403/040-010

Item no.: 756-5312/040-100
Sensor/Actuator cable; M12B socket; straight; 4-pole; Length: 10 m

www.wago.com/756-5312/040-100

Item no.: 756-5403/040-020
Sensor/Actuator cable; M12A socket; angled; M12A plug; straight; 4-pole; Length: 2 m

www.wago.com/756-5403/040-020



Item no.: 756-5508/040-010
Sensor/Actuator cable; M8 socket; straight; M12A plug; angled; 4-pole; Length: 1 m

www.wago.com/756-5508/040-010



Item no.: 756-5508/040-020
Sensor/Actuator cable; M8 socket; straight; M12A plug; angled; 4-pole; Length: 2 m

www.wago.com/756-5508/040-020

Configurable connectors

Item no.: 756-9202/040-000
Fitted pluggable connector; 4-pole; M12 plug, straight, A-coded; Spring

www.wago.com/756-9202/040-000

Item no.: 756-9205/040-000
Fitted pluggable connector; 4-pole; M12 plug, right angle; Spring

www.wago.com/756-9205/040-000



Item no.: 756-9711/050-000
Fitted pluggable connector; 5-pole, shielded; M12 socket, straight; IDC technology

www.wago.com/756-9711/050-000



Item no.: 756-9701/050-000
Fitted pluggable connector; 5-pole, shielded; M12 plug, straight; IDC technology

www.wago.com/756-9701/050-000

Subject to changes. Please also observe the further product documentation!

Configurable shielded connectors

Item no.: 756-9501/060-000

Fitted pluggable connector; 5-pole, shielded; M12 plug, straight, D-coded; Spring

www.wago.com/756-9501/060-000

Item no.: 756-9501/040-000

Accessories; M12 plug, right angle; 4-pole

www.wago.com/756-9501/040-000

Power cable



Item no.: 756-3501/050-075

Power cable; M12L socket; straight; 5-pole; Length: 7.5 m

www.wago.com/756-3501/050-075



Item no.: 756-3501/050-100

Power cable; M12L socket; straight; 5-pole; Length: 10 m

www.wago.com/756-3501/050-100



Item no.: 756-3501/050-150

Power cable; M12L socket; straight; 5-pole; Length: 15 m

www.wago.com/756-3501/050-150



Item no.: 756-3501/050-050

Power cable; M12L socket; straight; 5-pole; Length: 5 m

www.wago.com/756-3501/050-050



Item no.: 756-3502/050-050

Power cable; M12L socket; angled; 5-pole; Length: 5 m

www.wago.com/756-3502/050-050



Item no.: 756-3502/050-150

Power cable; M12L socket; angled; 5-pole; Length: 15 m

www.wago.com/756-3502/050-150



Item no.: 756-3502/050-075

Power cable; M12L socket; angled; 5-pole; Length: 7.5 m

www.wago.com/756-3502/050-075



Item no.: 756-3502/050-100

Power cable; M12L socket; angled; 5-pole; Length: 10 m

www.wago.com/756-3502/050-100

Subject to changes. Please also observe the further product documentation!

WAGO GmbH & Co. KG

Hansastr. 27













32423 Minden

Phone: +49571 887-0 | Fax: +49571 887-169













Email: info.de@wago.com | Web: www.wago.com

Do you have any questions about our products?

We are always happy to take your call at +49 (571) 887-44222.

	Item no.: 756-3503/050-075 Power cable; M12L plug; straight; 5-pole; Length: 7.5 m	www.wago.com/756-3503/050-075
	Item no.: 756-3503/050-150 Power cable; M12L plug; straight; 5-pole; Length: 15 m	www.wago.com/756-3503/050-150
	Item no.: 756-3503/050-100 Power cable; M12L plug; straight; 5-pole; Length: 10 m	www.wago.com/756-3503/050-100
	Item no.: 756-3505/050-003 Power cable; M12L socket; straight; M12L plug; straight; 5-pole; Length: 0.3 m	www.wago.com/756-3505/050-003
	Item no.: 756-3505/050-005 Power cable; M12L socket; straight; M12L plug; straight; 5-pole; Length: 0.5 m	www.wago.com/756-3505/050-005
	Item no.: 756-3505/050-020 Power cable; M12L socket; straight; M12L plug; straight; 5-pole; Length: 2 m	www.wago.com/756-3505/050-020
	Item no.: 756-3505/050-010 Power cable; M12L socket; straight; M12L plug; straight; 5-pole; Length: 1 m	www.wago.com/756-3505/050-010
	Item no.: 756-3505/050-050 Power cable; M12L socket; straight; M12L plug; straight; 5-pole; Length: 5 m	www.wago.com/756-3505/050-050
	Item no.: 756-3505/050-075 Power cable; M12L socket; straight; M12L plug; straight; 5-pole; Length: 7.5 m	www.wago.com/756-3505/050-075
	Item no.: 756-3505/050-100 Power cable; M12L socket; straight; M12L plug; straight; 5-pole; Length: 10 m	www.wago.com/756-3505/050-100
	Item no.: 756-3506/050-100 Power cable; M12L socket; angled; M12L plug; angled; 5-pole; Length: 10 m	www.wago.com/756-3506/050-100
	Item no.: 756-3506/050-075 Power cable; M12L socket; angled; M12L plug; angled; 5-pole; Length: 7.5 m	www.wago.com/756-3506/050-075
	Item no.: 756-3506/050-150 Power cable; M12L socket; angled; M12L plug; angled; 5-pole; Length: 15 m	www.wago.com/756-3506/050-150

Subject to changes. Please also observe the further product documentation!

	Item no.: 756-3501/050-020 Power cable; M12L socket; straight; 5-pole; Length: 2 m	www.wago.com/756-3501/050-020
	Item no.: 756-3502/050-020 Power cable; M12L socket; angled; 5-pole; Length: 2 m	www.wago.com/756-3502/050-020
	Item no.: 756-3503/050-020 Power cable; M12L plug; straight; 5-pole; Length: 2 m	www.wago.com/756-3503/050-020
	Item no.: 756-3503/050-050 Power cable; M12L plug; straight; 5-pole; Length: 5 m	www.wago.com/756-3503/050-050
	Item no.: 756-3504/050-020 Power cable; M12L plug; angled; 5-pole; Length: 2 m	www.wago.com/756-3504/050-020
	Item no.: 756-3504/050-050 Power cable; M12L plug; angled; 5-pole; Length: 5 m	www.wago.com/756-3504/050-050
	Item no.: 756-3504/050-075 Power cable; M12L plug; angled; 5-pole; Length: 7.5 m	www.wago.com/756-3504/050-075
	Item no.: 756-3504/050-100 Power cable; M12L plug; angled; 5-pole; Length: 10 m	www.wago.com/756-3504/050-100
	Item no.: 756-3504/050-150 Power cable; M12L plug; angled; 5-pole; Length: 15 m	www.wago.com/756-3504/050-150
	Item no.: 756-3505/050-150 Power cable; M12L socket; straight; M12L plug; straight; 5-pole; Length: 15 m	www.wago.com/756-3505/050-150
	Item no.: 756-3506/050-003 Power cable; M12L socket; angled; M12L plug; angled; 5-pole; Length: 0.3 m	www.wago.com/756-3506/050-003
	Item no.: 756-3506/050-005 Power cable; M12L socket; angled; M12L plug; angled; 5-pole; Length: 0.5 m	www.wago.com/756-3506/050-005

Subject to changes. Please also observe the further product documentation!



Item no.: 756-3506/050-020
Power cable; M12L socket; angled; M12L plug; angled; 5-pole; Length: 2 m

www.wago.com/756-3506/050-020



Item no.: 756-3506/050-010
Power cable; M12L socket; angled; M12L plug; angled; 5-pole; Length: 1 m

www.wago.com/756-3506/050-010



Item no.: 756-3506/050-050
Power cable; M12L socket; angled; M12L plug; angled; 5-pole; Length: 5 m

www.wago.com/756-3506/050-050

Distribution connector

Item no.: 756-5513/040-010
Sensor/Actuator cable; 2xM8 socket; straight; M12A plug; straight; 4-pole; Length: 1 m

www.wago.com/756-5513/040-010

Item no.: 756-5513/040-020
Sensor/Actuator cable; 2xM8 socket; straight; M12A plug; straight; 4-pole; Length: 2 m

www.wago.com/756-5513/040-020

Item no.: 756-5514/040-010
Sensor/Actuator cable; 2xM8 socket; angled; M12A plug; straight; 4-pole; Length: 1 m

www.wago.com/756-5514/040-010

Item no.: 756-5514/040-020
Sensor/Actuator cable; 2xM8 socket; angled; M12A plug; straight; 4-pole; Length: 2 m

www.wago.com/756-5514/040-020

Item no.: 756-5516/040-010
Sensor/Actuator cable; 2xM12 socket; straight; M12A plug; straight; 4-pole; Length: 1 m

www.wago.com/756-5516/040-010

Item no.: 756-5516/040-020
Sensor/Actuator cable; 2xM12 socket; straight; M12A plug; straight; 4-pole; Length: 2 m

www.wago.com/756-5516/040-020

Item no.: 756-5517/040-010
Sensor/Actuator cable; 2xM12 socket; angled; M12A plug; straight; 4-pole; Length: 1 m

www.wago.com/756-5517/040-010

Item no.: 756-5517/040-020
Sensor/Actuator cable; 2xM12 socket; angled; M12A plug; straight; 4-pole; Length: 2 m

www.wago.com/756-5517/040-020



Item no.: 756-9301/050-000
Accessories; 5-pole

www.wago.com/756-9301/050-000

Item no.: 756-9301/040-000
Accessories; 4-pole

www.wago.com/756-9301/040-000

Subject to changes. Please also observe the further product documentation!

Adapter



Item no.: 756-9503/040-000
Accessories; 4-pole

www.wago.com/756-9503/040-000

Item no.: 756-9504/040-000
Accessories; 4-pole

www.wago.com/756-9504/040-000

ETHERNET/PROFINET cable



Item no.: 756-1202/060-200
ETHERNET cable; M12D plug; angled; 4-pole; Length: 20 m

www.wago.com/756-1202/060-200



Item no.: 756-1201/060-100
ETHERNET cable; M12D plug; straight; 4-pole; Length: 10 m

www.wago.com/756-1201/060-100



Item no.: 756-1201/060-050
ETHERNET cable; M12D plug; straight; 4-pole; Length: 5 m

www.wago.com/756-1201/060-050



Item no.: 756-1203/060-050
ETHERNET cable; M12D plug; straight; M12D plug; straight; 4-pole; Length: 5 m

www.wago.com/756-1203/060-050



Item no.: 756-1203/060-020
ETHERNET cable; M12D plug; straight; M12D plug; straight; 4-pole; Length: 2 m

www.wago.com/756-1203/060-020



Item no.: 756-1202/060-020
ETHERNET cable; M12D plug; angled; 4-pole; Length: 2 m

www.wago.com/756-1202/060-020



Item no.: 756-1201/060-200
ETHERNET cable; M12D plug; straight; 4-pole; Length: 20 m

www.wago.com/756-1201/060-200



Item no.: 756-1204/060-050
ETHERNET cable; M12D plug; angled; M12D plug; angled; 4-pole; Length: 5 m





www.wago.com/756-1204/060-050



Item no.: 756-1204/060-100
ETHERNET cable; M12D plug; angled; M12D plug; angled; 4-pole; Length: 10 m

www.wago.com/756-1204/060-100

Subject to changes. Please also observe the further product documentation!

	Item no.: 756-1204/060-200 ETHERNET cable; M12D plug; angled; M12D plug; angled; 4-pole; Length: 20 m	www.wago.com/756-1204/060-200
	Item no.: 756-1203/060-200 ETHERNET cable; M12D plug; straight; M12D plug; straight; 4-pole; Length: 20 m	www.wago.com/756-1203/060-200
	Item no.: 756-1203/060-100 ETHERNET cable; M12D plug; straight; M12D plug; straight; 4-pole; Length: 10 m	www.wago.com/756-1203/060-100
	Item no.: 756-1204/060-010 ETHERNET cable; M12D plug; angled; M12D plug; angled; 4-pole; Length: 0.1 m	www.wago.com/756-1204/060-010
	Item no.: 756-1204/060-030 ETHERNET cable; M12D plug; angled; M12D plug; angled; 4-pole; Length: 3 m	www.wago.com/756-1204/060-030
	Item no.: 756-1204/060-020 ETHERNET cable; M12D plug; angled; M12D plug; angled; 4-pole; Length: 2 m	www.wago.com/756-1204/060-020
	Item no.: 756-1202/060-050 ETHERNET cable; M12D plug; angled; 4-pole; Length: 5 m	www.wago.com/756-1202/060-050
	Item no.: 756-1202/060-100 ETHERNET cable; M12D plug; angled; 4-pole; Length: 10 m	www.wago.com/756-1202/060-100
	Item no.: 756-1201/060-020 ETHERNET cable; M12D plug; straight; 4-pole; Length: 2 m	www.wago.com/756-1201/060-020

Downloads Documentation

Manual

16-Channel Digital Output; EtherCAT; 24 VDC / 2.0 A; 8xM12 Connection; WideLine	V 1.0.0 2021年6月8日	pdf 5.3 MB	Download
--	----------------------	---------------	----------

System Description

WAGO I/O System Field; General Product Information	pdf 708.2 kB	Download
--	-----------------	----------

Subject to changes. Please also observe the further product documentation!



Runtime Software

Firmware

EtherCat IO-Field 765-x2xx Firmware Download	V 01	zip	Download
WAGO_FW0765-x2xx_V01010017_IX01.zip	2021年7月23日	1.6 MB	

CAD/CAE-Data

CAD data

2D/3D Models 765-1203/100-000	URL	Download
-------------------------------	-----	----------

Device Files

Device Description File

(750-909) ESI file for EtherCAT 750 Series and 765 Series	23 2021年7月9日	zip 216.9 kB	Download
Gerätebeschreibungsdateien 765-42xx, 765-12xx, EtherCAT	V1_1_0_17	zip 72 B	Download

Environmental Product Compliance

Compliance Search

Environmental Product Compliance 765-1203/100-000	URL	Download
16-channel digital output; EtherCAT; DC 24 V / 2.0 A; 8xM12 connection; WideLine		

Installation Notes

Product family

WAGO I/O System Field
[Show all products from the family](#)

Subject to changes. Please also observe the further product documentation!